

ZYQ17080增压器外形尺寸图

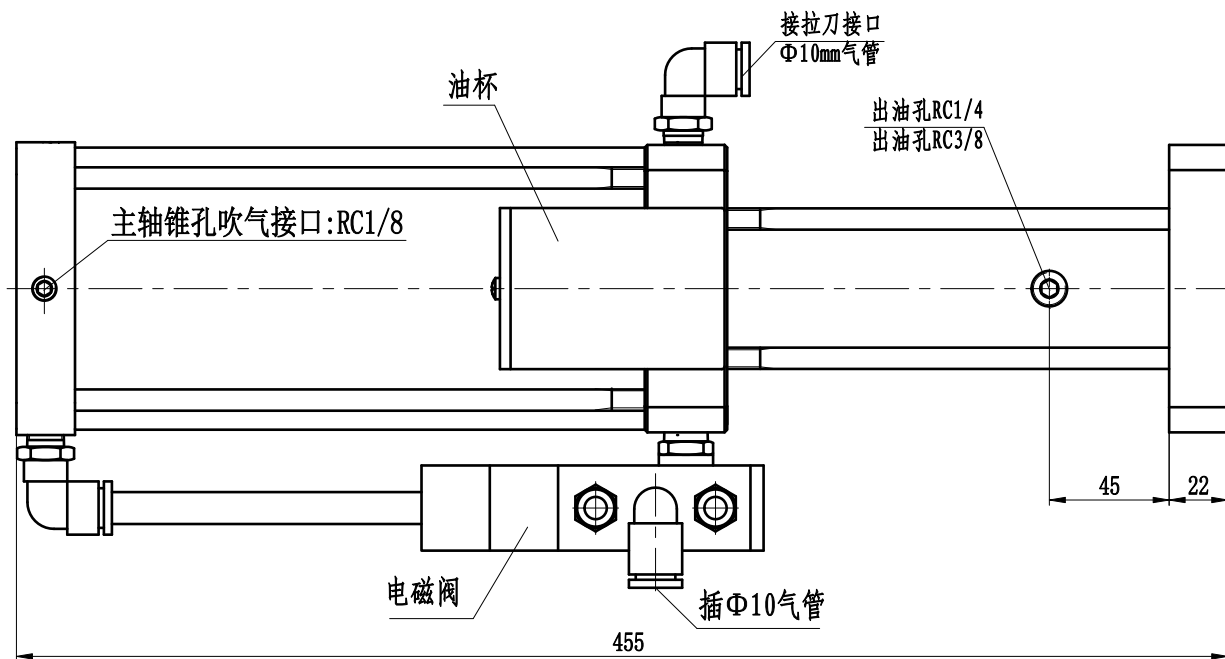
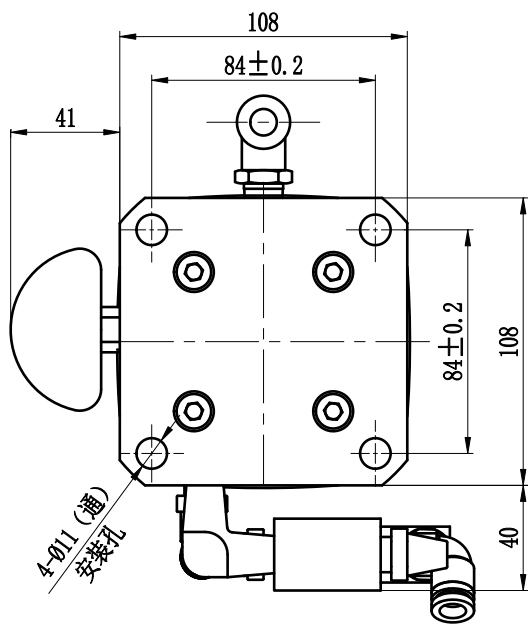

增压比: 1:17.35

出油量: 80CC